

JAMESTOWN175 SERIES FIXED WINDOWS

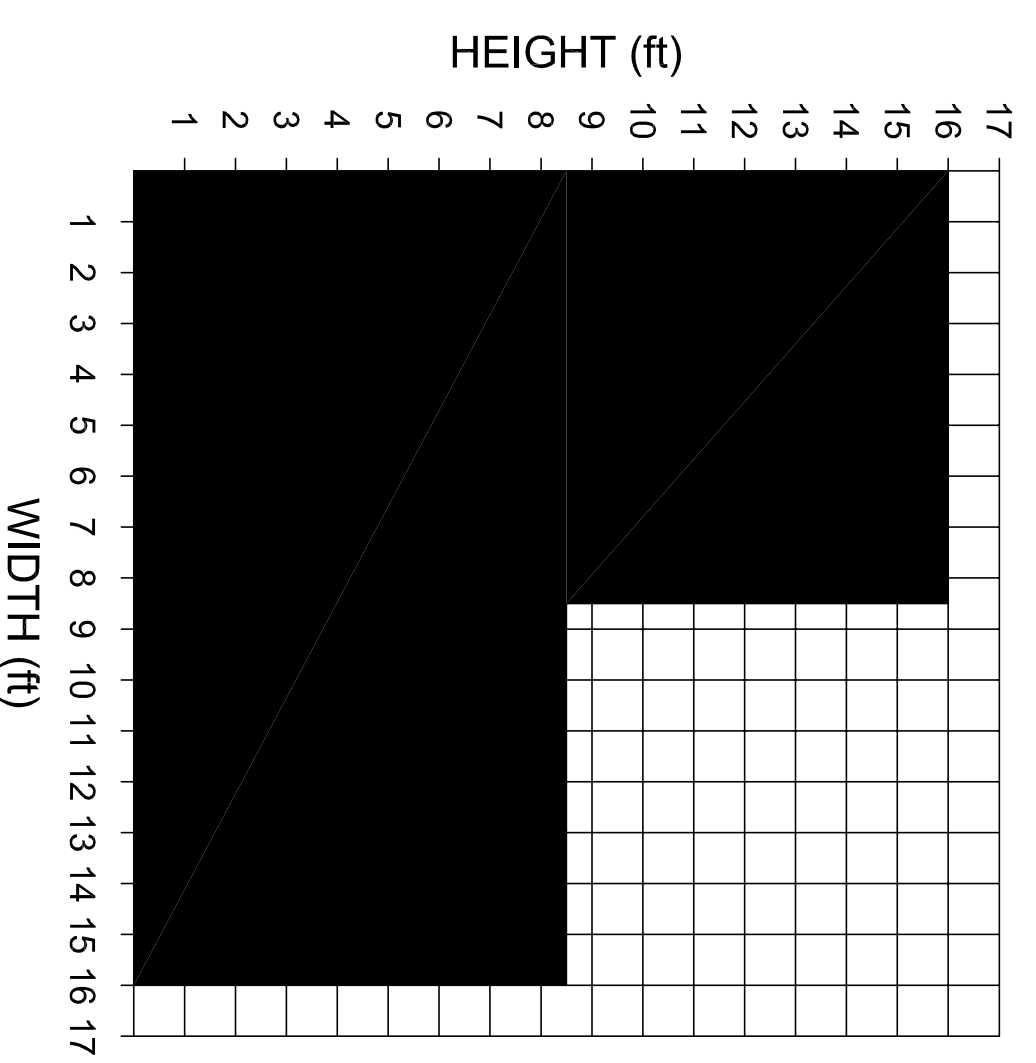

FOR WINDOW FRAME REQUIREMENTS EXCEEDING THE SIZES SHOWN, CONSULT HOPES FOR DESIGN ALTERNATIVES

JAMESTOWN175 SERIES TOP HUNG-OUT VENTILATORS

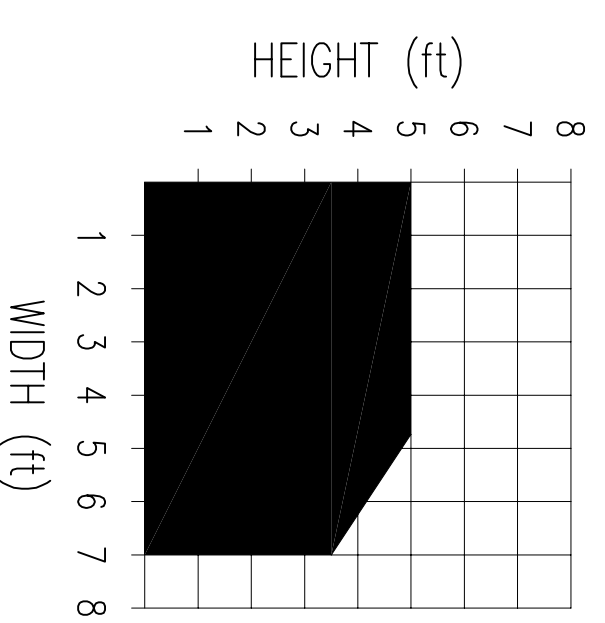

SIZES BASED ON 1" INSULATING GLASS WITH 1/4" PANES  
FOR VENTILATOR REQUIREMENTS EXCEEDING THE SIZES SHOWN, CONSULT HOPES FOR DESIGN ALTERNATIVES

JAMESTOWN175 SERIES SWINGING DOORS

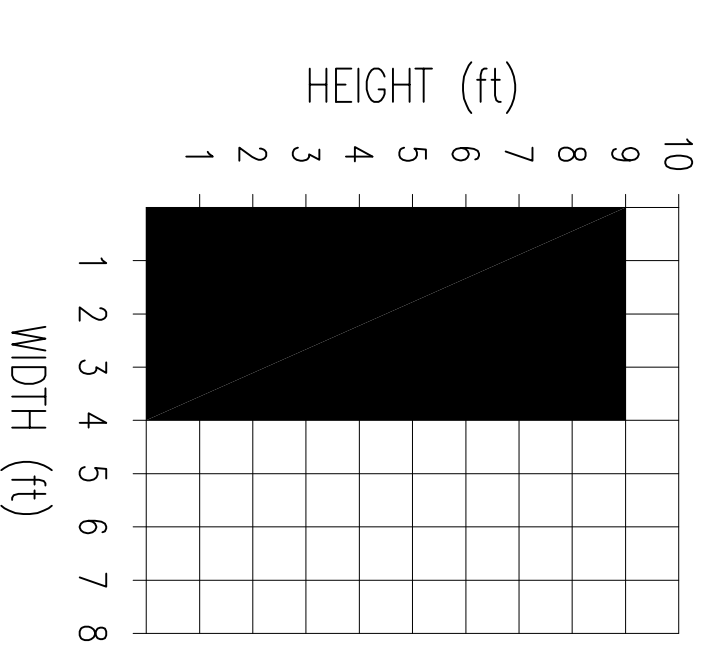

SIZES BASED ON 1" INSULATING GLASS WITH 1/4" PANES  
FOR DOOR REQUIREMENTS EXCEEDING THE SIZES SHOWN, CONSULT HOPES FOR DESIGN ALTERNATIVES

JAMESTOWN175 SERIES PROJECT-OUT VENTILATORS

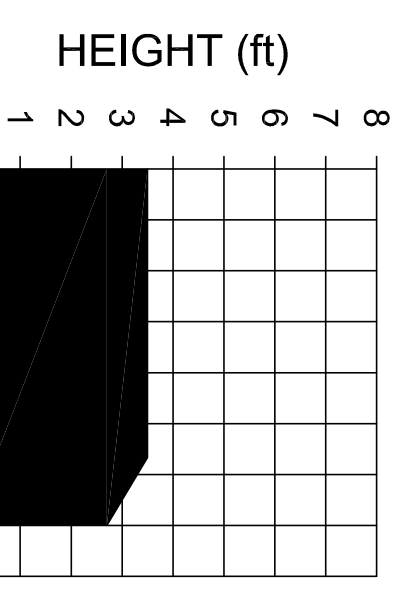
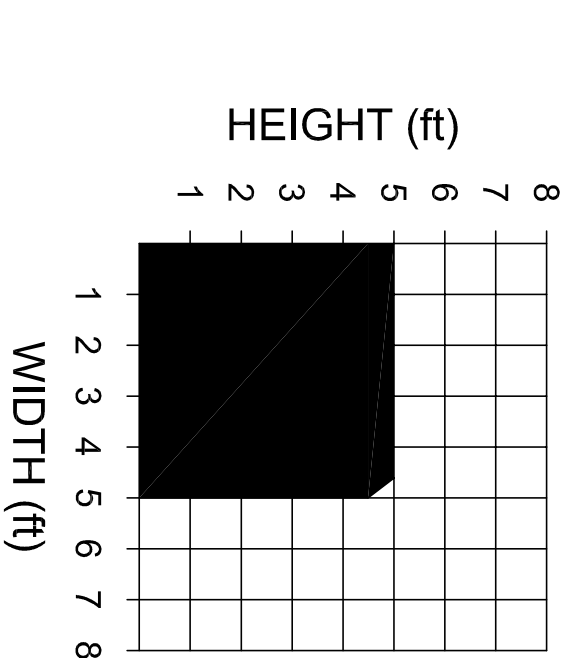

MOTORIZED OPERATOR

SIZES BASED ON 1" INSULATING GLASS WITH 1/4" PANES  
FOR VENTILATOR REQUIREMENTS EXCEEDING THE SIZES SHOWN, CONSULT HOPES FOR DESIGN ALTERNATIVES

JAMESTOWN175 SERIES VERTICALLY PIVOTED VENTILATORS

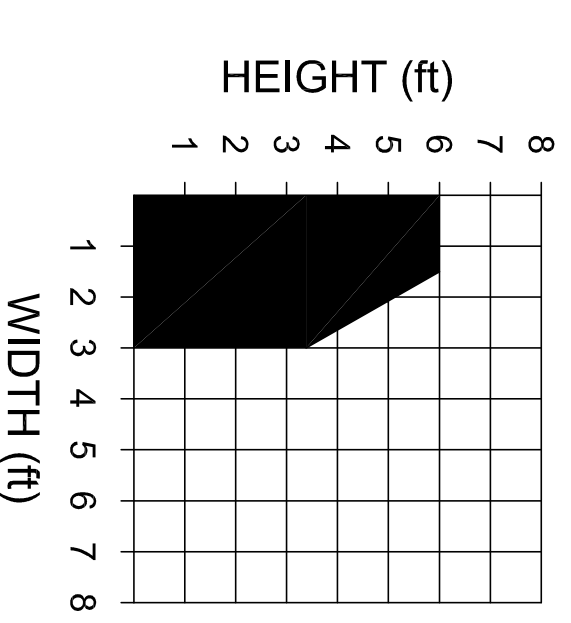

JAMESTOWN175 SERIES HORIZONTALLY PIVOTED VENTILATORS

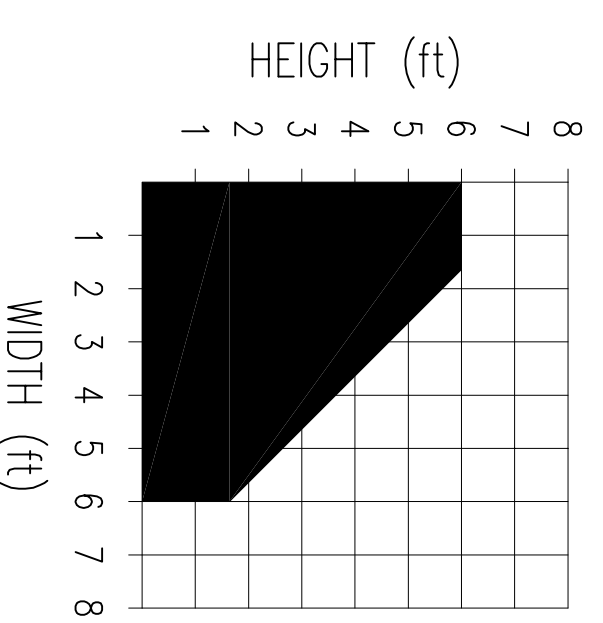

SIZES BASED ON 1" INSULATING GLASS WITH 1/4" PANES  
FOR VENTILATOR REQUIREMENTS EXCEEDING THE SIZES SHOWN, CONSULT HOPES FOR DESIGN ALTERNATIVES

JAMESTOWN175 SERIES PROJECT-IN VENTILATORS

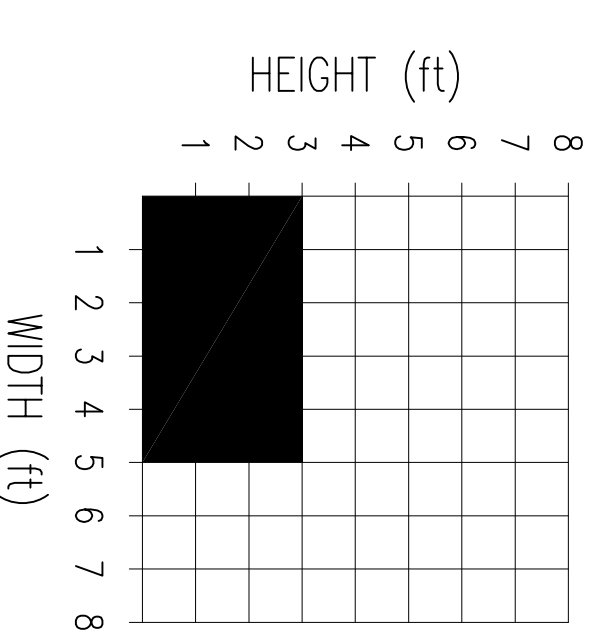

SIZES BASED ON 1" INSULATING GLASS WITH 1/4" PANES  
FOR VENTILATOR REQUIREMENTS EXCEEDING THE SIZES SHOWN, CONSULT HOPES FOR DESIGN ALTERNATIVES

JAMESTOWN175 SERIES CASEMENT VENTILATORS

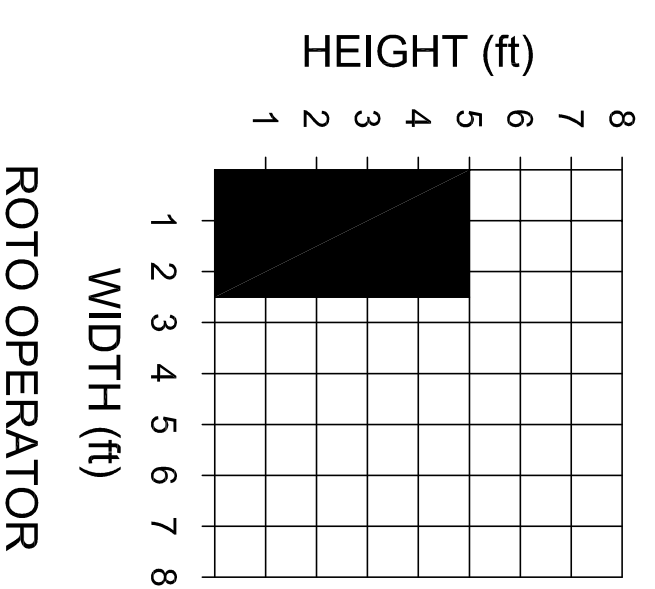
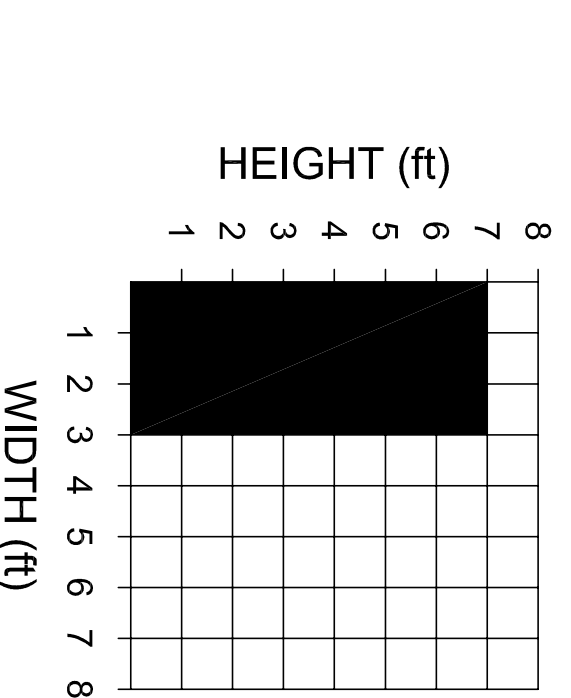

ROTO OPERATOR

JAMESTOWN175 SERIES SINGLE & DOUBLE HUNG VENTILATORS

COUNTER BALANCE

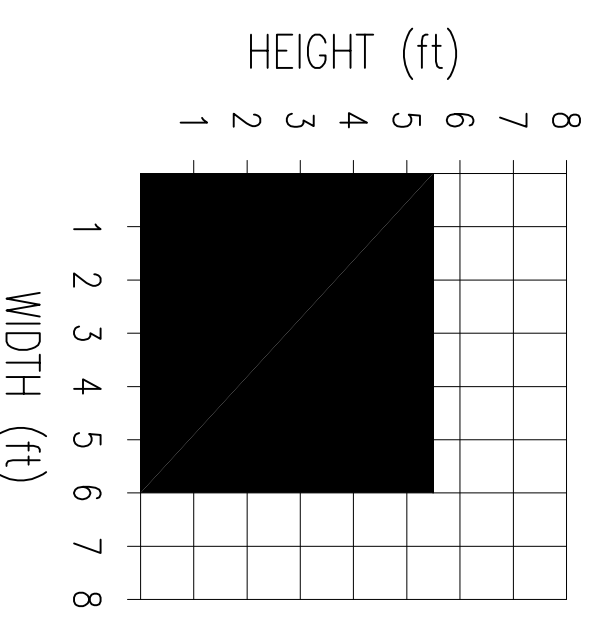

SPIRAL BALANCE

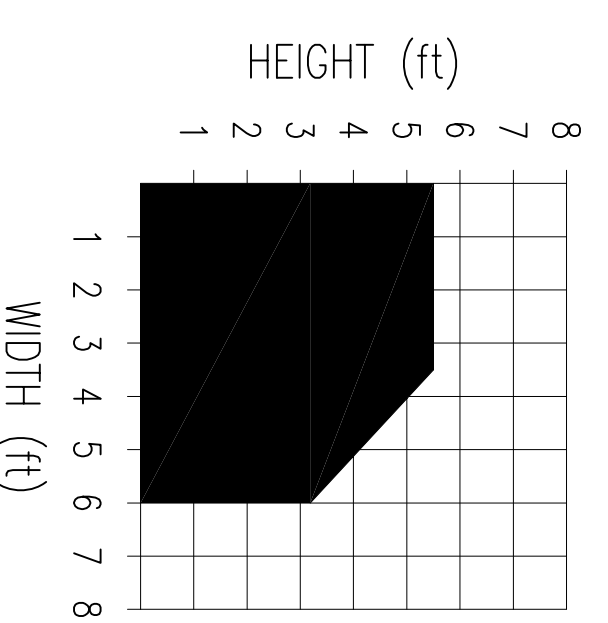

SIZES BASED ON 1" INSULATING GLASS WITH 1/4" PANES  
FOR VENTILATOR REQUIREMENTS EXCEEDING THE SIZES SHOWN, CONSULT HOPES FOR DESIGN ALTERNATIVES

5000 SERIES LIFT AND SLIDE WINDOWS

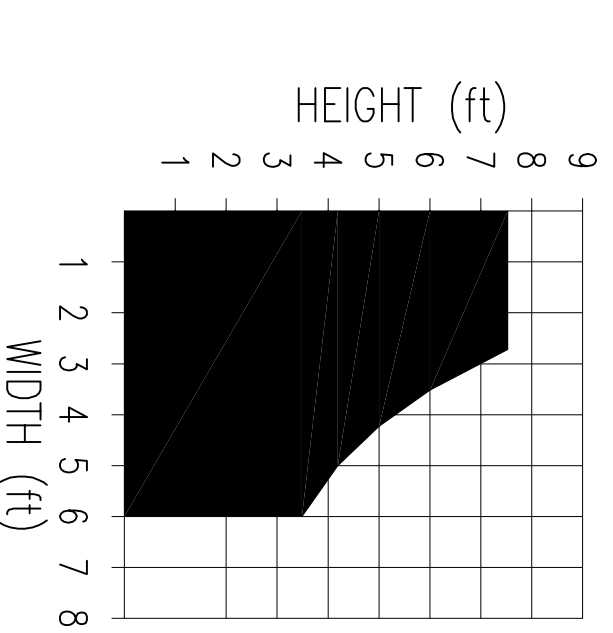

WEIGHT LIMIT PER PANEL - 198 LBS  
SIZES BASED ON 1" INSULATING GLASS WITH 1/4" PANES  
FOR DOOR REQUIREMENTS EXCEEDING THE SIZES SHOWN, CONSULT HOPES FOR DESIGN ALTERNATIVES

HOPKINS SERIES SLIDE AND FOLD DOORS

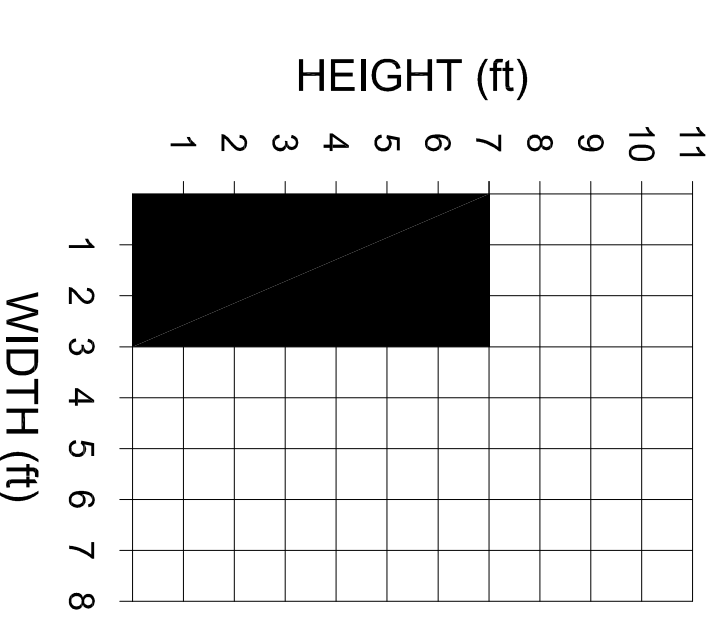

E3 SYSTEM-WEIGHT LIMIT PER PANEL - 176 LBS

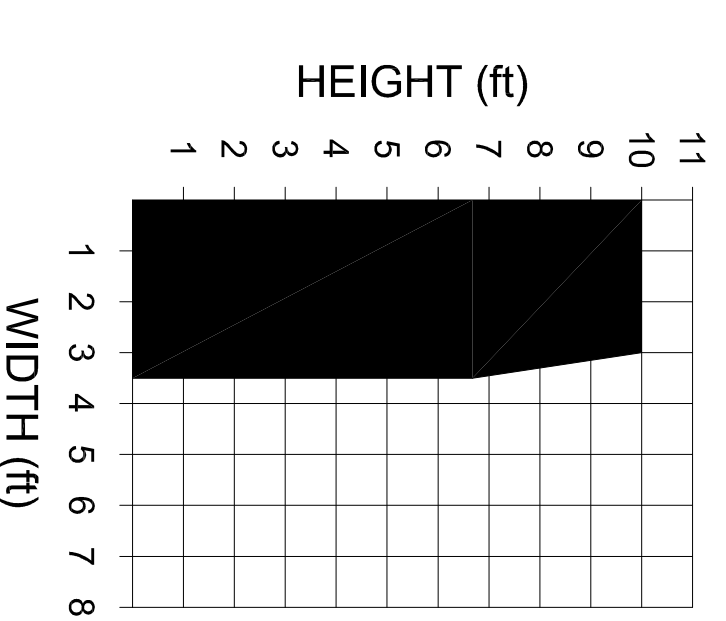

E4 SYSTEM-WEIGHT LIMIT PER PANEL - 264 LBS

SIZES BASED ON 1" INSULATING GLASS WITH 1/4" PANES  
FOR DOOR REQUIREMENTS EXCEEDING THE SIZES SHOWN, CONSULT HOPES FOR DESIGN ALTERNATIVES

5000 SERIES LIFT AND SLIDE DOORS

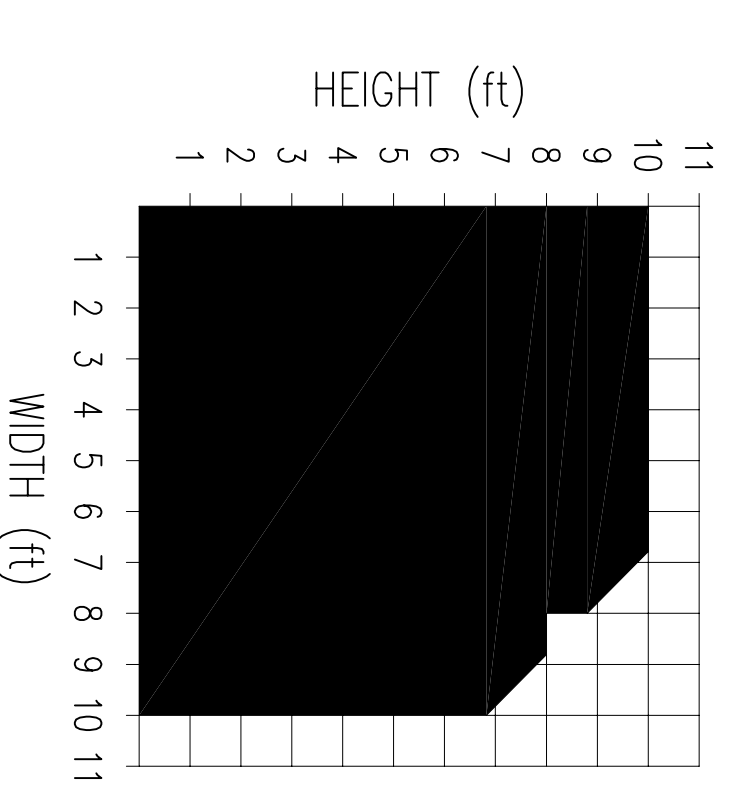

WEIGHT LIMIT PER PANEL - 550 LBS  
SIZES BASED ON 1" INSULATING GLASS WITH 1/4" PANES  
FOR DOOR REQUIREMENTS EXCEEDING THE SIZES SHOWN, CONSULT HOPES FOR DESIGN ALTERNATIVES